

SUMMARY: FRAME TYPES (COMMON)

“AS” SERIES FRAMES:

- Assembly: Welded or KD (knock-down).
- Gauge: 16 gauge, galvanized, galvanized is also available.
 - Heaviest gauge (16ga) standard frame. Thicker custom order gauges are available.
- Uses:
 - For use with 1-3/4” doors.
 - Masonry: Typically installed when the wall is being built (new construction) using masonry anchors.
 - Drywall: Typically installed using stud anchors, after the studs are up, before the drywall is installed.
 - Often used when replacing existing frames.

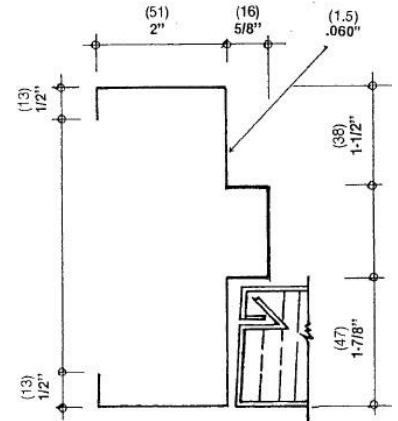

CASED OPEN FRAMES:

- NOTE: This frame does not have stops/soffit.
- Assembly: Welded or KD (knock-down).
- Gauge: 16 gauge, galvanized
- Uses:
 - To finish an opening in a wall, no door(s).
 - For single or paired Double Acting door openings
 - Masonry: Typically installed when the wall is being built (new construction) using masonry anchors.
 - Drywall: Typically installed using stud anchors, after the studs are up, before the drywall is installed.

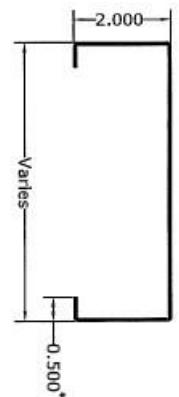

CASING BY OTHERS:

- Assembly: KD (knock-down).
- Gauge: 16 gauge, galvanized
- Uses:
 - For use with 1-3/4” doors.
 - To be installed after the wall is completed. Fastened to the wall via holes in the frame faces that are covered with the casing/trim material selected and supplied by others. Fasteners are not included.
 - For single or paired door openings.
 - NOTE: Frame throat must be supplied, special order, to correspond with the precise wall thickness.

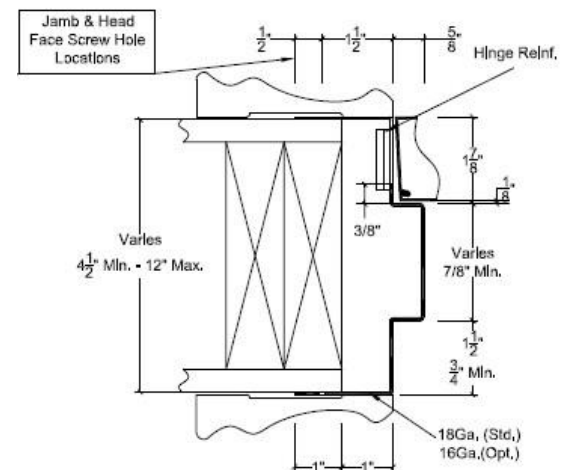

SUMMARY: FRAME TYPES (COMMON)

“DE” DOUBLE EGRESS FRAME:

- Assembly: Welded.
- Gauge: 16 gauge, galvanized, galvanized is also available.
 - Heaviest gauge (16ga) standard frame. Thicker custom order gauges are available.
- Uses:
 - For use with 1-3/4” doors.
 - Masonry: Typically installed when the wall is being built (new construction) using masonry anchors.
 - Drywall: Typically installed using stud anchors, after the studs are up, before the drywall is installed.
 - This is a Double/Pair Frame with doors that swing in the same direction, same hand, typically LHR.
 - Least likely to be LH or RH. Typically, Cross-Corridor Door Openings in Hospitals, Nursing Homes and Schools.
 - Usually Fire Rated.
 - Follows the Traffic Flow of the Corridor to exit the building. Serves as HORIZONTAL EXIT.

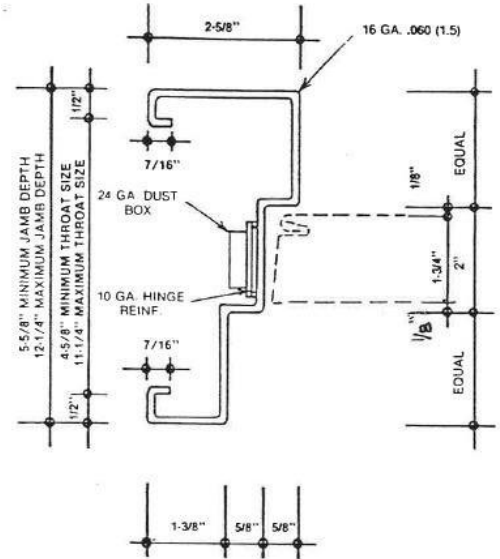

DRYWALL FRAMES FOR 1-3/8” DOORS:

- Assembly: KD (knock-down).
- Gauge: 22 gauge, galvanized
- Uses:
 - Interior, residential applications for 1-3/8” doors.

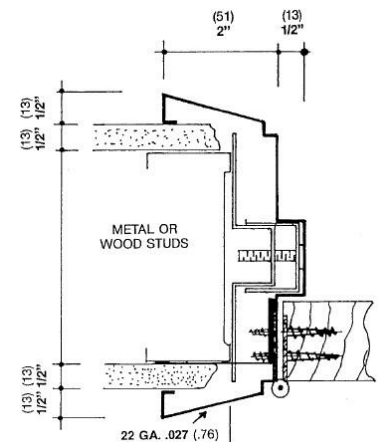

DRYWALL FRAME FOR 1-3/4 ” DOORS (“K” SERIES) :

- Assembly: KD (knock-down).
- Gauge: 18 gauge, galvanized
- Uses:
 - For use with 1-3/4” doors.
 - Drywall: Installed after the after the drywall is installed.

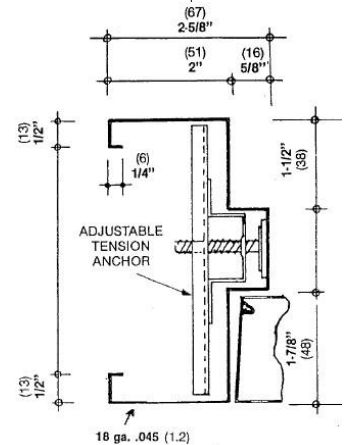

SUMMARY: FRAME TYPES (COMMON)

EXPANDABLE FRAMES:

- NOTE: These frames “sandwich” around the wall and are fastened to the wall using screw holes that are on the frame faces. It is important to purchase the frame with the proper throat adjustability.
- Assembly: KD (knock-down).
- Gauge: 16 gauge, galvanized
- Uses:
 - For use with 1-3/4” doors.
 - This frame can be used on any wall type.

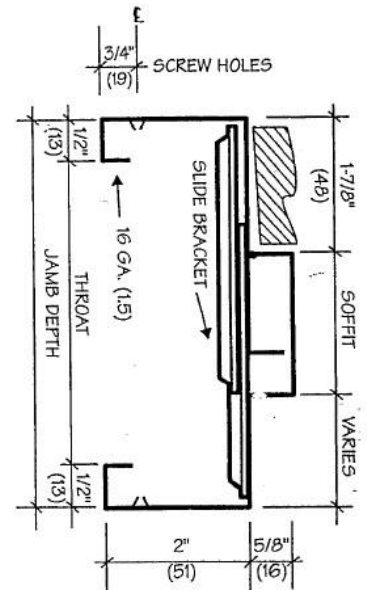

THERMALLY BROKEN FRAMES:

- Note 1: These custom order frames are built with the jamb depth/profile consisting of 2 pieces. These 2 pieces are typically at the door rebate and door stop where the 2 pieces are joined with a material that resists thermal conductivity. This is to reduce the transfer of hot/cold and improve energy efficiency in the building.
- Note 2: These frames have equal 1-7/8” rebates.
- Assembly: Welded or KD (knock-down).
- Gauge: 16 gauge, galvanized, galvanized is also available.
- Uses:
 - For use with 1-3/4” doors.
 - Masonry: Typically installed when the wall is being built (new construction) using masonry anchors.
 - Drywall: Typically installed using stud anchors, after the studs are up, before the drywall is installed.
 - Often used when replacing existing frames.

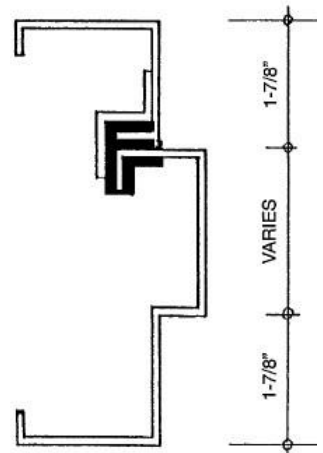

PAINTING INSTRUCTIONS – GALVANNEAL (unprimed) FRAMES & DOORS:

- 1) Prior to painting, inspect all sides/surfaces of the frames/doors for damage. Repair scratches by re-priming only. Repair dents by filling damaged area with an automotive-type body filler. Once the filler has cured, sand to a smooth feather-edged surface and prime with a zinc-rich air-drying primer.
- 2) Clean frame/door with mild solvents to remove any dirt, oil, grease or foreign particles. Cleaning agent must be compatible with finish paint.
- 3) Apply two coats of high quality lower-sheen finish paint. Higher gloss paints are not recommended. Follow the finish paint manufacturer’s instructions for best results.